



**User Manual for the
*HEC-GV3-DN Option Card***

**DeviceNet Network Communication
Option Board for use with
Reliance Electric GV3000 AC Drive**

**Third Edition
22 September 1998**

MAN0096-03

PREFACE

This manual explains how to use the Horner Electric's DeviceNet Network Communication Option Board for use with Reliance Electric GV3000 AC Drive.

Copyright (C) 1998 Horner Electric, Inc., 640 North Sherman Drive Indianapolis, Indiana 46201. All rights reserved. No part of this publication may be reproduced, transmitted, transcribed, stored in a retrieval system, or translated into any language or computer language, in any form by any means, electronic, mechanical, magnetic, optical, chemical, manual or otherwise, without the prior agreement and written permission of Horner Electric, Inc.

All software described in this document or media is also copyrighted material subject to the terms and conditions of the Horner Software License Agreement.

Information in this document is subject to change without notice and does not represent a commitment on the part of Horner Electric, Inc.

DeviceNet™ is a registered trademark of Open DeviceNet Vendor Association, Inc. (OVDA)

GV3000™ and Reliance™ are registered trademarks of Reliance Electric Company or its subsidiaries.

For user manual updates, contact Horner Electric Advanced Products Group, Technical Support Division, at (317) 916-4274 or visit our website at www.heapg.com.

LIMITED WARRANTY AND LIMITATION OF LIABILITY

Horner Electric, Inc. ("HE") warrants to the original purchaser that DeviceNet Network Communication Option Board (HEC GV3000 DN) for use with Reliance Electric GV3000 AC Drive manufactured by HE is free from defects in material and workmanship under normal use and service. The obligation of HE under this warranty shall be limited to the repair or exchange of any part or parts which may prove defective under normal use and service within two (2) years from the date of manufacture or eighteen (18) months from the date of installation by the original purchaser whichever occurs first, such defect to be disclosed to the satisfaction of HE after examination by HE of the allegedly defective part or parts. THIS WARRANTY IS EXPRESSLY IN LIEU OF ALL OTHER WARRANTIES EXPRESSED OR IMPLIED INCLUDING THE WARRANTIES OF MERCHANTABILITY AND FITNESS FOR USE AND OF ALL OTHER OBLIGATIONS OR LIABILITIES AND HE NEITHER ASSUMES, NOR AUTHORIZES ANY OTHER PERSON TO ASSUME FOR HE, ANY OTHER LIABILITY IN CONNECTION WITH THE SALE OF THIS DeviceNet Network Communication Option Board for use with Reliance Electric GV3000 AC. THIS WARRANTY SHALL NOT APPLY TO THIS DeviceNet Network Communication Option Board for use with Reliance Electric GV3000 AC Drive OR ANY PART THEREOF WHICH HAS BEEN SUBJECT TO ACCIDENT, NEGLIGENCE, ALTERATION, ABUSE, OR MISUSE. HE MAKES NO WARRANTY WHATSOEVER IN RESPECT TO ACCESSORIES OR PARTS NOT SUPPLIED BY HE. THE TERM "ORIGINAL PURCHASER", AS USED IN THIS WARRANTY, SHALL BE DEEMED TO MEAN THAT PERSON FOR WHOM THE OPERATOR CONTROL STATION IS ORIGINALLY INSTALLED. THIS WARRANTY SHALL APPLY ONLY WITHIN THE BOUNDARIES OF THE CONTINENTAL UNITED STATES.

In no event, whether as a result of breach of contract, warranty, tort (including negligence) or otherwise, shall HE or its suppliers be liable of any special, consequential, incidental or penal damages including, but not limited to, loss of profit or revenues, loss of use of the products or any associated equipment, damage to associated equipment, cost of capital, cost of substitute products, facilities, services or replacement power, down time costs, or claims of original purchaser's customers for such damages.

To obtain warranty service, return the product to your distributor with a description of the problem, proof of purchase, postage paid, insured and in a suitable package.

ABOUT PROGRAMMING EXAMPLES

Any example programs and program segments in this manual or provided on accompanying diskettes are included solely for illustrative purposes. Due to the many variables and requirements associated with any particular installation, Horner Electric cannot assume responsibility or liability for actual use based on the examples and diagrams. It is the sole responsibility of the system designer utilizing DeviceNet Network Communication Option Board for use with Reliance Electric GV3000 AC Drive to appropriately design the end system, to appropriately integrate the Reliance Electric GV3000 AC Drive and to make safety provisions for the end equipment as is usual and customary in industrial applications as defined in any codes or standards which apply.

Note: The programming examples shown in this manual are for illustrative purposes only. Proper machine operation is the sole responsibility of the system integrator.

TABLE OF CONTENTS

PREFACE..... 2

LIMITED WARRANTY AND LIMITATION OF LIABILITY 3

ABOUT PROGRAMMING EXAMPLES 3

TABLE OF CONTENTS..... 4

SAFETY NOTICES..... 6

CHAPTER 1: INTRODUCTION..... 8

 1.1 General..... 8

 1.2 Product Description..... 8

 1.3 Additional Information 9

 1.4 Electronic Data Sheet (EDS) File 9

CHAPTER 2: DEVICENET™ OVERVIEW10

 2.1 DeviceNet Interface Specifications.....10

 2.2 Introduction to DeviceNet.....10

CHAPTER 3: INSTALLATION.....12

 3.1 General.....12

 3.2 Installing the Network Communication Option Board.....12

 3.2.1 Safety Notices.....12

 3.2.2 Procedures.....13

 3.3 Connecting the GV3000 Controller to a DeviceNet Network18

CHAPTER 4: SETUP20

 4.1 General.....20

 4.2 Network Communication Parameters20

 4.3 Diagnostic LEDs21

 4.4 Drive Operation Parameters21

CHAPTER 5: NETWORK PROGRAMMING22

 5.1 Drive Data Registers Overview22

 5.1.1 General.....22

 5.1.2 Input Data Update Response.....22

 5.1.3 Output Data Update Response.....23

 5.1.4 Limitation on Data Registers Accessible (Basic/Extended)23

 5.1.5 Input Data Transfer Conditions.....23

 5.1.6 Output Data Transfer Conditions.....24

 5.1.7 Data Transfer Summary.....24

 5.1.8 Tune/Config Transfer Synchronization Flag25

 5.1.9 Parameter Processing Error Flag26

 5.1.10 Data Retention Timing Requirements.....26

 5.1.11 Inaccessible Drive Parameters (Keypad Only parameters).....27

 5.2 Building Network Messages27

 5.2.1 General.....27

 5.2.2 Loss-of-Communications Considerations.....28

 5.2.3 Poll Connection Data28

 5.2.4 Bit-Strobed Connection Data.....30

 5.2.5 Explicit Connection Data.....31

APPENDIX A: ACCESS TO DRIVE DATA REGISTERS.....32

A1 DRIVE STATUS.....32

 A1.1 General32

 A1.2 Drive Control.....32

 A1.2.1 General.....32

 A1.2.2 Register 32: Drive Control Word33

 A1.2.3 Register 33: Network Speed/torque Reference.....33

APPENDIX B: CONFIGURING DRIVE WITH DEVICENET MANAGER.....34

B1 DEVICENET MANAGER.....34

B1.1 General.....34
B1.2 Installation of EDS file.....34
B1.3 Adding a GV3000 Device to a Project.....36
B1.4 Configuring a GV3000 Device.....38
 B1.4.1 Display Configuration.....38
 B1.4.2 Off-line/On-line Configuration38
 B1.4.3 Display Groups (Current/Preload).....38
 B1.4.4 Modifying a (Preload) parameter.....39
 B1.4.5 Loading Preloaded Parameters to Drive.....39
APPENDIX C: DEFAULT TUNE/CONFIGURATION REGISTERS.....41

SAFETY NOTICES

a. DANGER

Only qualified electrical personnel familiar with the construction and operation of this equipment and the hazards involved should install it. Read and understand this manual in its entirety before proceeding. Failure to observe this precaution could result in severe bodily injury or loss of life.

b. DANGER

The user is responsible for conforming to the nec/cec and all other applicable local codes. Wiring practices, grounding, disconnects, and overcurrent protection are of particular importance. Failure to observe this precaution could result in severe bodily injury or loss of life.

c. DANGER

Do not install modification boards with power applied to the controller. Disconnect and lock out incoming power before attempting such installation. Failure to observe this precaution could result in severe bodily injury or loss of life.

d. WARNING

Only qualified individuals who are thoroughly familiar with the particular application may install, operate and maintain this equipment. Before any work is performed, read and understand this instruction manual as well as the appropriate drive instruction manual(s). Failure to observe this precaution could result in severe bodily injury.

THIS PAGE INTENTIONALLY LEFT BLANK

CHAPTER 1: INTRODUCTION

1.1 General

Horner Electric's DeviceNet™ Network Communication Option Board (M/N 2DV3000) allows a Reliance GV3000 AC Drive to be upgraded with DeviceNet capability. This Option Board functions as DeviceNet "slave" node and provides the GV3000 with the ability to communicate over a DeviceNet network with a host of industrial control products. Both control and/or monitoring are easily accomplished through a DeviceNet Scanner (master) residing in a PLC or some other control device.

The option board mounts below the regulator board inside the GV3000 controller and connects to the regulator board through an existing flexible ribbon cable parallel-bus port. Power for the option board comes from the GV3000 controller power supply.

In normal operation, the drive can be completely controlled via the network option board. In many applications, there may be only a network interface connection, hard-wired emergency stop (function loss input), and three-phase input and output power wiring. Start, stop, fault code retrieval and complete control can be accomplished over the DeviceNet network.

1.2 Product Description

The mechanical and electrical characteristics of the DeviceNet Network Communication Option Board are described as follows:

a. Mechanical Description

The DeviceNet Network Communication Option Board is a printed circuit assembly that mounts inside a GV3000 Controller. It connects to the regulator board within the controller via a ribbon cable. It has a standard DeviceNet 5-pin "pluggable" screw-terminal connector which is used to connect a DeviceNet cable (dual twisted pairs with shield).

b. Electrical Description

The DeviceNet Network Communication Option Board contains its own microprocessor. The microprocessor connects to one port of the board's dual port memory while the other port interfaces to the GV3000 regulator. The board contains a watchdog timer which is enabled when power is turned on the the controller. The microprocessor must reset the watchdog timer within a specified period or the microprocessor will shut down and result in an "F-60" code on the GV3000 controller's front-panel display.

At power-up, the microprocessor will run diagnostics on the CPU, EPROM, RAM, serial I/O and dual port memory. If there is a fault during diagnostics, an "F-60" error will be logged.

1.3 Additional Information

The user must be familiar with all of the manuals that describe the system configuration which is used. This may include, but is not limited to, the following:

- a. D2-3323 GV3000 AC General Purpose (Volts/Hz) and Vector Duty Drive Software Startup and Reference Manual Version 4.0
- b. D2-3323 Installing and Operating the Three-Phase Input Three-Phase Output GV3000 AC V*S Drive.
- c. D2-3324 GV3000 AC Power Modules Hardware Reference, Installation and Troubleshooting 1-150 HP @ 380-460 VAC Version 4.0 (or later)

1.4 Electronic Data Sheet (EDS) File

Provided with the network option card is a diskette containing an Electronic Data Sheet. This Electronic Data Sheet is a formatted data file which provides configuration data for use with a DeviceNet configuration utility such as DeviceNet Manager. Such configurations provide the end user with a convenient method of configuring remote DeviceNet devices while on-line.

CHAPTER 2: DEVICENET™ OVERVIEW

2.1 DeviceNet Interface Specifications

a. DeviceNet™ Compliance:

Conforms to DeviceNet™ standard Volume I Rel 1.3 and Volume II Rel. 1.2.
 Group 2 Server Only - Supporting Explicit, Poll and Bit-Strobed I/O connections.
 Generic Profile.
 Node Isolation consuming bus power only for communications isolation.
 Pluggable bus connector.
 Keypad configurable Mac Id (no default can be established).
 Keypad configurable Baud rate (no default can be established).

b. Network Power Consumption:

Each option card requires a maximum of 95mA @ 11VDC of DeviceNet™ network power for the transceiver circuit. Input voltage range is from 11VDC to 24VDC.

c. Connections:

	Produced	Consumed
Explicit message	32 bytes (max)	36 bytes (max)
Poll message	18/30 bytes*	6/46 bytes* †
Bit-Strobe message	0 bytes	1 bit †

Note: *Poll message size has two selectable sizes to meet specific application.
 †Zero Length Consumed packet is defined for Poll and Strobe message.

d. Configuration:

The GV3000 may be configured conventionally through the attached keypad or remotely through the DeviceNet network.

An EDS file is provided such that DeviceNet configuration tools (i.e., DeviceNet Manager) may be used to configure the device. (Note: Access to the first 64 drive registers only.)

2.2 Introduction to DeviceNet

DeviceNet™ is a high-speed, twisted pair + power pair + shield network primarily used to retrieve low-level I/O data. In addition to accessing I/O, the network can be used to configure and modify operation of a remote node. By conforming to the DeviceNet™ specification, low-level devices from multiple vendors can co-exist on the same network and be accessed from the same high-level device.

A DeviceNet™ network can support up to 64 nodes on a single network. Baud rates of 125K, 250K, and 500Kbaud can be selected based on the total span of the network. The network is typically configured in a trunkline-dropline, which allows node removal without terminating the network. The network requires resistor termination at both ends of the trunkline.

Typical DeviceNet™ installations require a high-level device or master to access the data from low-level devices. Low-level devices, which simply control local hardware, are usually Group-2-Only Server devices. A Group-2-Only-Server device provides the protocol services of the Predefined Master/Slave Connection Set. While DeviceNet™ provides many connections and services, the Predefined Master/Slave Connection Set provides a limited and known subset of services which are sufficient yet simple to access through most DeviceNet™ Scanners. Since a Group-2-Only-Server has predefined connections, it does NOT support the Unconnected Message Manager (UCMM).

The Master is a high-level device, which is used to establish communication, initiate communication and transfer data with the low-level slave devices. A scanner is a type of master which is used to access data from a slave device in real-time. Other masters may also exist such as a device which is used as a low-level device configuration tool (i.e. DeviceNet™ Manager). A low-level device which supports Group-2-Only-Server services can only be connected to one master at a time.

The typical connections provided by a Group-2-Server-Only devices are Explicit, Poll and Bit-Strobed. The Explicit connection provides both visible and hidden services. Explicit services which are visible to the user usually provide low priority access to a device's parameters (run-time or configuration) which are accessible over the network. Explicit hidden services are used by the master for network management such as to establish other services such as the Poll and Bit-Strobed connections. A Poll connection is a higher priority and high-speed connection that moves a small set of I/O data on a consistent basis. A Bit-Strobed connection is a higher priority connection that broadcasts bit-packed control information in one packet for all low-level devices on the network. Each device will uniquely own one bit in that packet which is usually used for network synchronization (Start/Stop). A device may also return a small packet of high priority response data to a Bit-Strobe broadcast.

Generally data on each connection can be sent or received. The data a device sends is referred to as Produced data and that received as Consumed data. With Poll or Bit-Strobed connections, the size of a produced and consumed data packet are not necessarily equal but are consistent and must be known in advance to configure the master device. The device manufacture will provide data tables describing both the produced and consumed data packet size, and location of each variable in its associated packet.

CHAPTER 3: INSTALLATION

3.1 General

Chapter Three describes how to install the DeviceNet Network Communication Option Board into the GV3000 controller and how to connect the controller to a DeviceNet network.

3.2 Installing the Network Communication Option Board

3.2.1 Safety Notices

a. DANGER

Only qualified electrical personnel familiar with the construction and operation of this equipment and the hazards involved should install it. Read and understand this manual in its entirety before proceeding. Failure to observe this precaution could result in severe bodily injury or loss of life.

b. DANGER

The user is responsible for conforming to the nec/cec and all other applicable local codes. Wiring practices, grounding, disconnects, and overcurrent protection are of particular importance. Failure to observe this precaution could result in severe bodily injury or loss of life.

c. DANGER

Do not install modification boards with power applied to the controller. Disconnect and lock out incoming power before attempting such installation. Failure to observe this precaution could result in severe bodily injury or loss of life.

d. WARNING

Only qualified individuals who are thoroughly familiar with the particular application may install, operate and maintain this equipment. Before any work is performed, read and understand this instruction manual as well as the appropriate drive instruction manual(s). Failure to observe this precaution could result in severe bodily injury.

3.2.2 Procedures

3.2.2.1 Use the following procedure to install the Network Communication Option Board. **Refer to Figures 3.1 – 3.4 for mounting locations.**

1. Disconnect and lock out all incoming power to the GV3000 controller
2. Loosen the four (4) captive screws at the corners of the GV3000 controller cover and remove the cover.
3. Disconnect the ribbon cable that runs between the right side of the regulator board and the daughter board from the connector on the daughter board.
4. If the controller is equipped with a fan, disconnect the fan power leads from the connector on the power board.
5. Remove the three (3) screws that fasten the stand-off bracket (to which the regulator board and keypad are mounted) to the controller base, and remove the regulator board/keypad/bracket assembly from the controller.
6. Invert the regulator board/keypad/bracket assembly so that the keypad is on the bottom. The ribbon cable that connects to the daughter board will extend from the left of the regulator board and the ribbon cable that connects to the DeviceNet Network Communications Option Board will extend from the right of the regulator board.
7. Connect the ribbon cable that extends from the right side of the regulator board to the connector on the DeviceNet Network Communication Option Board.
8. Mount the DeviceNet Network Communication Option Board to the underside of the stand-off bracket. Use the two (2) M3 self-tapping screws and lockwashers (provided) on the right side. Use the two (2) plastic rivets to fasten the left side of the board to the stand-off bracket.
9. Re-install the regulator board/keypad/bracket assembly to the controller base.
10. Re-connect the fan power leads.
11. Re-connect the ribbon cable to the daughter board.
12. Route the DeviceNet network cable through the leftmost opening at the bottom of the controller. With the contacts numbered 1-5 from left to right (pin 5 nearest the "D" connector), connect as described below:
13. Re-install the controller cover.

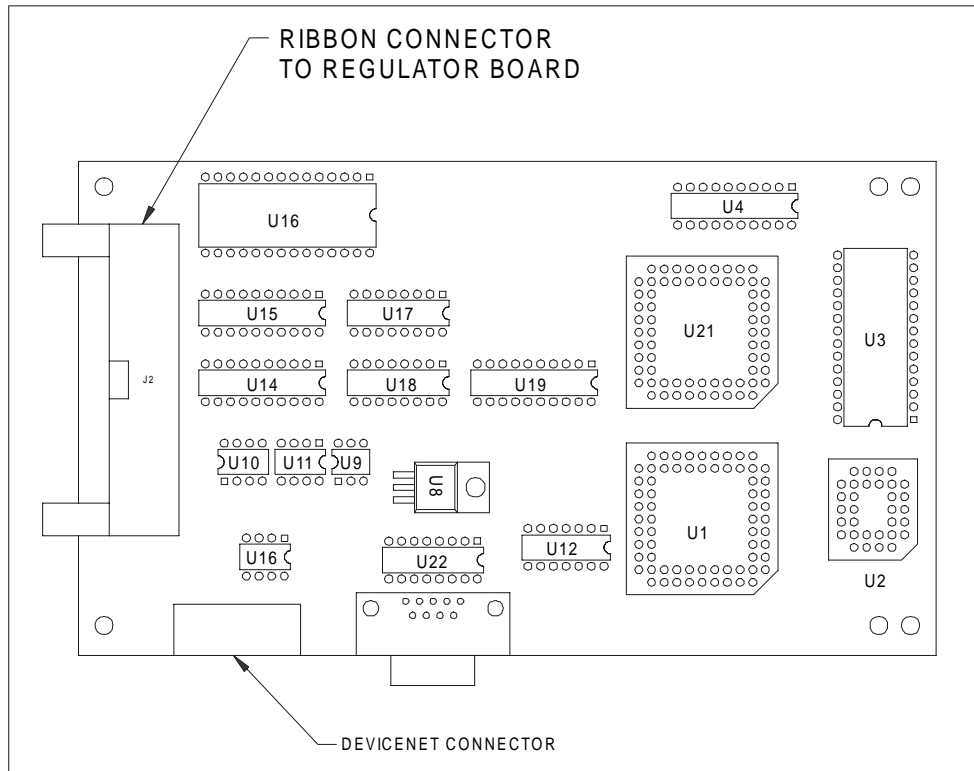

Figure 3.1 – DeviceNet Option Board (HEC-GV3-DN)

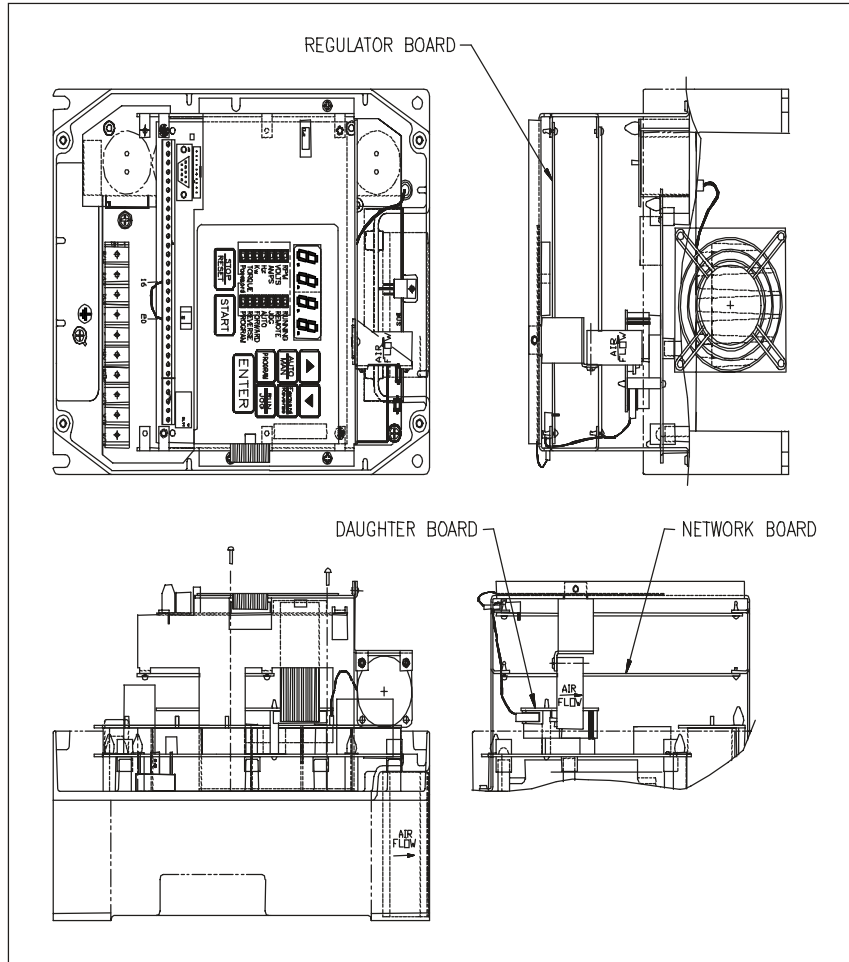

Figure 3.2- GV3000 Drive (1-5 HP)

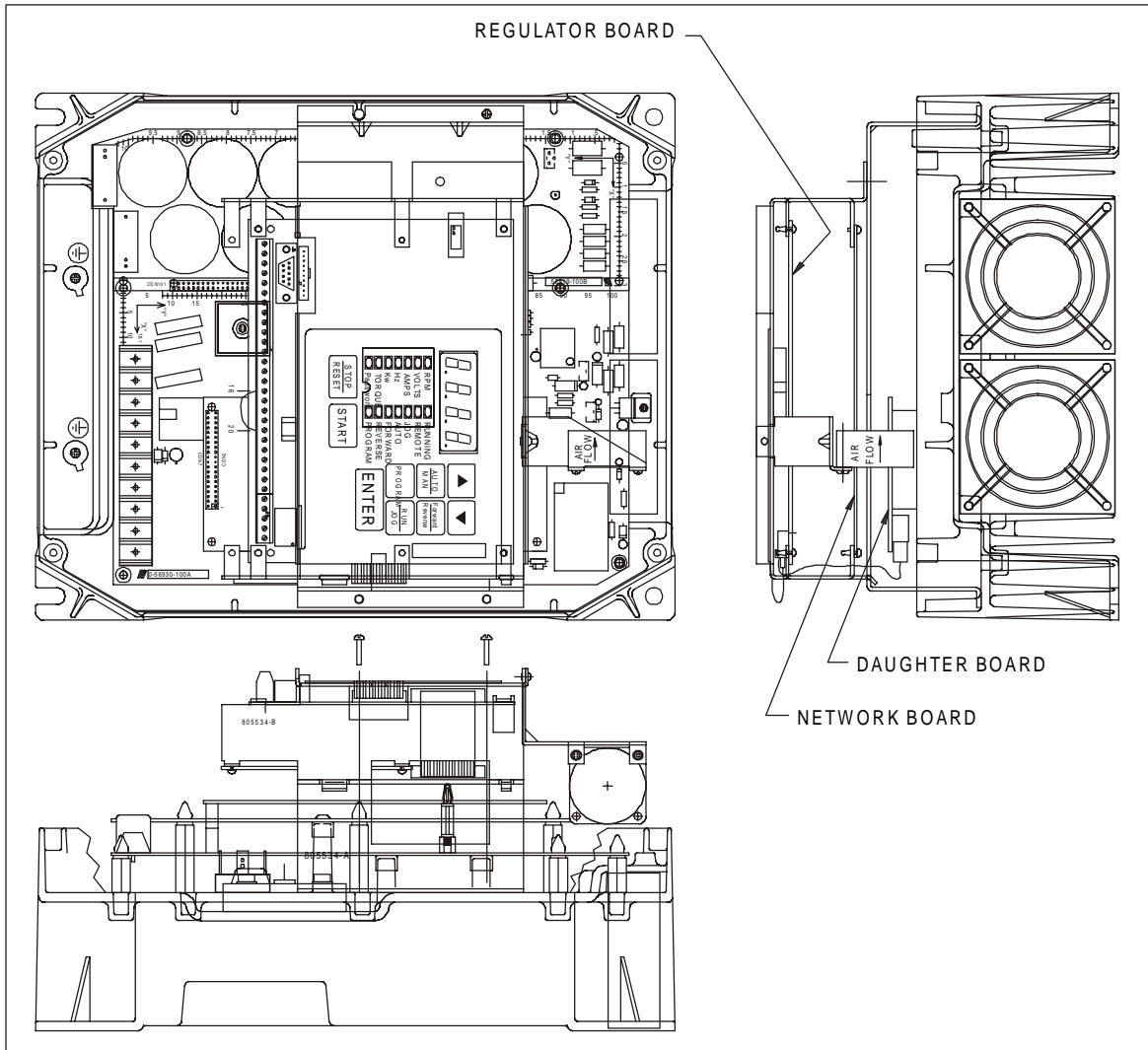

Figure 3.3 - GV3000 Drive (7.5-10 HP)

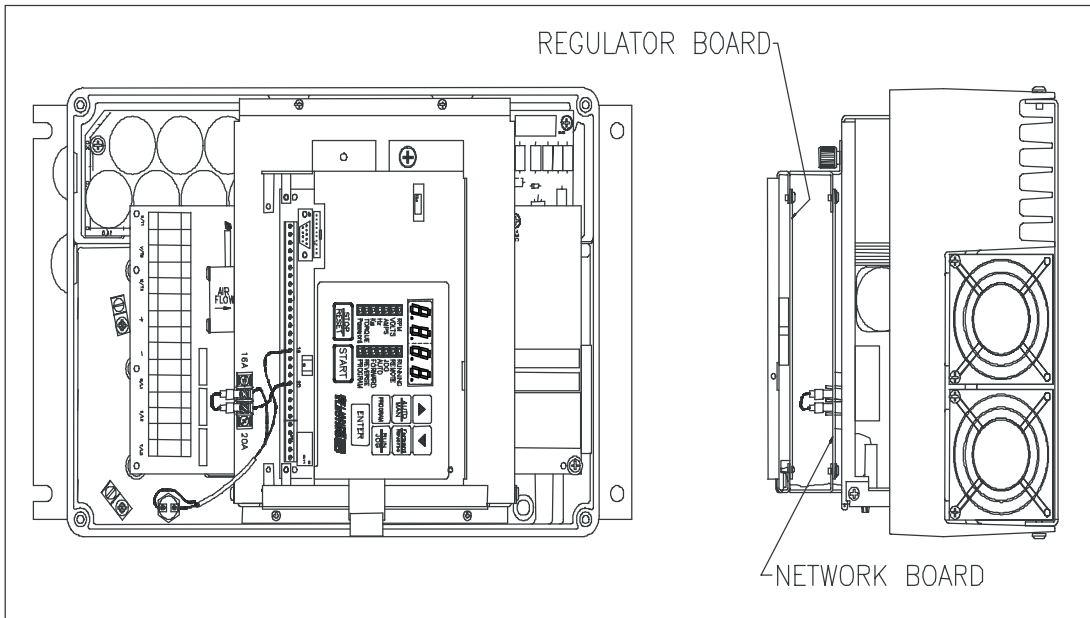
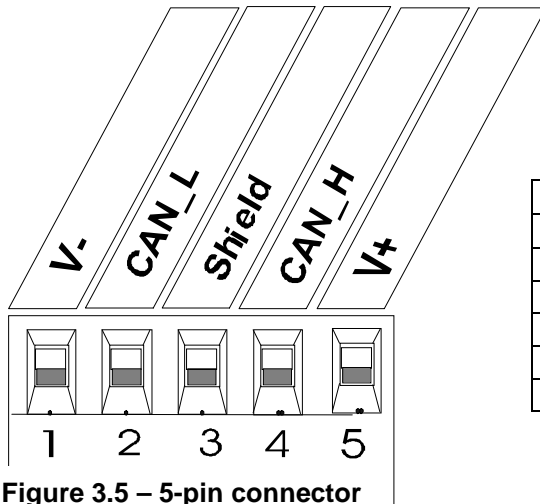

Figure 3.4 - GV3000 Drive (15-25 HP)

3.3 Connecting the GV3000 Controller to a DeviceNet Network

When connecting to the DeviceNet network, the GV3000 controller should be wired with the same cabling and termination as any other DeviceNet device. **Refer to Volume 1 of the DeviceNet Specification, Chapter 9.**



**Figure 3.5 – 5-pin connector
(DeviceNet wiring)**

Terminal	Signal	Description
1	V-	Power -
2	CAN_L	Signal -
3	Drain	Shield
4	CAN_H	Signal +
5	V+	Power +

Note: When connecting to the GV3000 drive (5-pin connector), use Table 3.1 to multi-drop between drives.

NOTES

CHAPTER 4: SETUP

4.1 General

This section describes how to configure the GV3000 controller (containing the DeviceNet Network Communication Option Board) for use on the DeviceNet network. Refer to the **GV3000 Installation and Operation Instruction Manual (D2-3287)** for more information on the drive parameters (P.xxx) described in Section 4.2. During setup, it is assumed that the network option board is currently installed in the GV3000 as described in Chapter Three.

4.2 Network Communication Parameters

The drive becomes active on the DeviceNet network after the following steps are performed. The steps need to be followed in the order listed to prevent drive fault(s).

1. Apply power to the drive.
2. Using the keypad on the drive, access the "Network Drop Number" parameter (**P.060**) and assign a valid DeviceNet network address to the drive (only addresses 1 through 55 are available).
3. Referring to the GV3000/SE AC General Purpose (Volts/Hertz) and Vector Duty Drive Software Start-Up and Reference Manual:
 - a. Determine and set the "Network Connection Type" parameter (**P.061**)

Note: Because the Poll Connection (I/O) and the EDS Mapping (configuration) limits access to the first 64 drive registers, the Network Connection Type parameter should remain 0-Basic for most applications.

- b. Determine and set the "Communications Loss Response" parameter (**P.062**)

Note: The DV3000 Option card behaves the same as the AutoMax Network Communications Option Board with respect to loss of communications. Please note the warnings and precautions described in the **GV3000 Installation and Operation Instruction Manual (D2-3287)**. For safety reasons, some modes require a hard-wired stop-switch.

4. Set the "DeviceNet Baud Rate" parameter (**P.063**) to the desired value described in Table 4.1. Note that this parameter sets both the network baud rate and the size of the data packets (and the drive parameters accessed) passed on the Poll connection. For more information on control and control+config packets see Section: 5.2.

Table 4.1 – Values for DeviceNet Baud Rate	
Value	Description
0	No network communications (Disables DeviceNet access)
1	125K baud, control only (Poll connection data width, See section 5.2.2)
2	250K baud, control only
3	500K baud, control only
4	125K baud, control+config
5	250K baud, control+config
6	500K baud, control+config

5. If the drive is to be controlled remotely via the DeviceNet network, the "Operation Control Source" parameter (**P.000**) must be set to "OP". If this parameter is not set to "OP", the network controller can still monitor the drive without taking control of it.
6. Remove power to the drive. The parameters configured in the steps above are retained in the drive's non-volatile memory, but do not take effect until the drive is powered up.
7. Connect the Network Option board to the network via the standard "pluggable" DeviceNet connector (See **Section 3.3** for wiring information).
8. Apply power to the DeviceNet network. At this point, the network option board will immediately attempt to "log on" to the DeviceNet network. The diagnostic LEDs on the option card can be used to determine the status of the log-on.

4.3 Diagnostic LEDs

With the drive's protective cover removed, two LEDs will be visible on the front of the network option card. These LEDs: MS (Module Status) and NS (Network Status) can be useful in determining network problems.

MS	NS	Problem/Condition
Off	Off	No power to drive
Red (Solid)	Off	Load firmware mode (contact Tech. Support)
Red (Flash)	Off	No power to network connection
Grn (Flash)	Off	P.063 set to 0 (no configuration)
Grn (Solid)	Off	No Network activity
"	Grn (Flash)	Active on Network but no connections
"	Grn (Solid)	Network connection to master
"	Red (Flash)	Network lost connection to master
"	Red (Solid)	Network fault (duplicate id, high bus errors, etc.)

4.4 Drive Operation Parameters

If the Drive's operation parameters have not yet been entered, they may be entered either through the drive's keypad or through a network configuration utility. See Appendix B for information on using DeviceNet Manager for network configuration of the drive's parameters.

CHAPTER 5: NETWORK PROGRAMMING

5.1 Drive Data Registers Overview

5.1.1 General

The drive is monitored and controlled over the network by reading and writing network commands (Explicit, Poll or Bit-Strobed) to the drive's data registers. The data registers are addressed over the network by a register number (Reg #) and contain 16 bit values. The data registers are divided into separate types according to function. Generally speaking, the **Tune/Config** registers hold an image of the P.xxx and U.xxx parameters accessible by the drive's keypad and the **Control/Reference** registers hold an image of the drives physical inputs (start, stop, speed ref., etc). When the drive is configured for network control and other certain conditions are met, the drive registers accessed by the network option card are selected as an alternate source for controlling the drive as opposed to the keypad and/or physical input.

Network data written to the drive's data registers is buffered before it is transferred to the drive's internal regulator. In order to minimize regulator board CPU loading, the rate of transfer of register data to the drive regulator varies for different data register types. Additionally, some register data transfer are blocked until additional conditions are met. The sections that follow describe each data type for input and output register data along with the drive's response and conditions for acceptance of transfer. The presented response times do not include DeviceNet transfer times.

The drive data registers which may be read or modified are listed in a table in Horner Electric's Supplement (SUP-0096). The table lists the register number, type, access and description for each register.

5.1.2 Input Data Update Response

The drive's input data is categorized as one of three types: control/reference, tunable or configurable. Control/reference inputs include data which require fast update rates. This includes data such as sequencing inputs (start, stop, run/jog, fwd/rev, etc.) and speed/torque reference. Control/reference inputs are transferred from the data registers to the regulator every speed loop scan period (for the GV3000, every 5 milliseconds), or as often as it is required by the drive. For example, if the drive is configured to obtain its torque reference from the option port, it reads this data from the option port every torque loop control scan.

Tunable inputs include parameters which typically require modification or adjustment while the drive is running. Tunable data includes parameters such as accel/decel rates, min/max limits, gains or offsets, etc. Tunable inputs are transferred from the data register to the regulator whenever the regulator performs the processing of new tunable parameters. This occurs approximately every 100 milliseconds while the drive is running or stopped.

Configurable inputs include parameters, which alter the way that the drive operates in such a way that they cannot be modified while the drive is running. Configuration data includes parameters such as reference source selection, I/O configuration, motor/tach nameplate data, etc. Configurable inputs are transferred from the data registers to the regulator whenever the regulator performs processing of new configuration parameters. This occurs approximately every 100 milliseconds while the drive is stopped. Values sent from the network master while the drive is running are not read in and used by the drive regulator until the drive is stopped.

5.1.3 Output Data Update Response

The drive output data is categorized as one of two types: runtime signal data or tunable configuration and status data. Runtime signal data includes things such as selected speed reference value, sequencing status (ready, running, etc.), drive fault flags, terminal block digital inputs state, and front-panel display mode values (RPM, Volts, Amps). The information is transferred from the regulator to the data registers every speed loop scan period (for the GV3000, every 5 milliseconds).

Tunable configuration and status data includes all other information provided by the drive which is not defined as runtime signal data. This would typically include all drive parameter values. When accessed via the DeviceNet explicit connection, the data provides a complete image of how the drive is configured and operating. Tunable configuration and status data are transferred from the regulator to the data registers whenever the regulator performs the processing of new tunable and configurable input parameters. This occurs every 100 milliseconds.

5.1.4 Limitation on Data Registers Accessible (Basic/Extended)

The data registers are divided into a Basic and Extended set. The Basic set covers the first 64 data registers while the Extended set includes the Basic set plus all remaining data registers. Drive parameter "Network Connection Type" (**P.061**) selects the set and determines which data registers will be updated or read by the regulator. While configured to the Basic set, the drive will block transfer (reading and writing) to data registers above Register number 64.

Normally, networks are not used to access to data registers above register number 64. Therefore, this option is especially useful in limiting the number of Tune/Config parameters which are modified in the regulator when using the Tune/Config option described below. Since the network option board does not provide default values for those Tune/Config data registers over register number 64, each Tune/Config data register above that number must be initialized over the network when using the Extended set and the Tune/Config option.

Note: Use care not to inadvertently set Reg. 61 since this register (P.061) enables the Extended set.

5.1.5 Input Data Transfer Conditions

The network option board must be actively communicating with a master (Poll connection active), and it must be selected as the drive's control source (P.000 = OP(2)) in order for **any inputs to be transferred** from the data registers to the drive regulator. Note that the keypad can still be used to change parameter values when the drive control source is the network option. However, any changes made via the keypad are overwritten with data register values when the next input data update occurs. This needs to be kept in mind if parameter changes need to be made while the network option is the control source for the drive.

In addition, a network-controlled "Tune/Cnfg input enable" bit (Drive Control Word: Reg 32, bit 14) is provided to enable the transfer of tunable and configurable register data to the drive regulator. **Until this bit is set ON (1), only Control/Reference data registers are read in by the drive regulator.** This gives the master's application program direct control over when tunable and configurable parameter values are read in by the drive, if at all.

For example, if a master loads Tune/Config parameters, it must first initialize the tunable and configurable parameter data through **Explicit** network messages to the appropriate data registers. Then, a **Poll** network message setting the "Tune/Cnfg input enable" bit in the Drive Control Word enables the transfer of this data to the drive's data registers. Once the Tune/Config register data is transferred to the drive's regulator, the "Tune/Cnfg input enable" bit must be reset to prevent regulator overhead and un-expected changes in Tune/Config parameters. The "Tune/Config Update synchronization flag" described in Section 5.1.8 can be used to determine when the regulator has transferred the data. Those Tune/Config data registers not explicitly preloaded through Explicit network messages contain default values as described in the Appendix C. Note that the default value is not the same as the value previously loaded by the keypad.

Alternately, should the user prefer to leave the tune/config so that inputs are set exclusively by the keypad and that the network only modifies the control/reference data to the drive, the master should not set the "Tune/Cnfg input enable" bit during any network message writes to the Drive Control Word (Reg 32). The drive is, then, configured locally, but start, stop, reset and reference are sent from the network master.

Note: The user needs to exercise caution to prevent the unintentional setting of the Tune/Cnfg input enable bit (Reg 32, bit 14). This could cause the drive to transfer uninitialized tune/config data from the network option card to the drive, which could radically change the operation of the drive.

5.1.6 Output Data Transfer Conditions

All regulator output data is transferred to the data registers continuously. The network does not have to be active, and the network option does not have to be selected as the drive control source (P.000). No output enable control bit is necessary.

5.1.7 Data Transfer Summary

Table 5.1 summarizes the response times to the different drive data types described earlier in this Sections 5.1.2, 5.1.3, and 5.1.6.

Table 5.1 – Transfer between Data Registers and the Drive Regulator			
Direction	Category	Conditions	Rate
Input (to drive)	Control / Reference	drive running or stopped	5ms
	Tunable	drive running or stopped	100ms
	Configurable	Drive stopped	100ms
Output (from drive)	Runtime	Always	5ms
	Tunable, Configuration & Status	Always	100ms

The following logic summarizes the conditions which effect transfer of input and output register data to the drive's regulator.

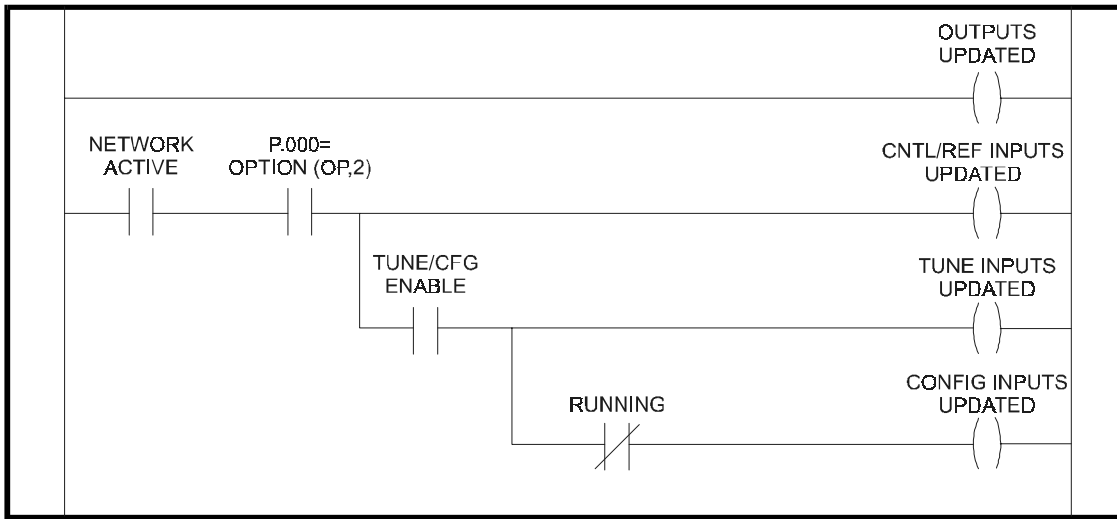

Figure 5.1 - Transfer Condition Logic Summary

5.1.8 Tune/Config Transfer Synchronization Flag

To allow the network master's application program to determine when tunable and configurable inputs have been updated in the drive, a sync write bit (Drive Control Word: Reg. 32, bit 15) is provided which is copied to a sync read bit (Status Word: Reg. 0, bit 7) by the drive. The drive copies the sync write bit to the sync read bit after the drive has read in and processed all tunable and/or configurable input registers. The "Tune/Cnfg input enable" bit must be set (1) in order for this to happen. Note that configurable type inputs are only read in by the drive while it is not running. This does not affect the copying of the sync bit since tunable inputs are still transferred.

By toggling the sync bit in the master and by monitoring the copied value from the drive, the master's application program determines when the drive has read in data. This feature is provided for those applications which may require this type of synchronization. It is not necessary for the master's application program to use it as it has no affect on drive operation.

To determine when changes to tunable and configurable data on the drive have been completed, the master performs the following sequence:

1. Modify the tunable and/or configurable register data in the appropriate network register(s).
2. Set the Tune/Cnfg input enable flag (if not already set).
3. Toggle the network synchronization flag.
4. Monitor the loopbacked copy (read register) of the network synchronization flag until it equals the value written in step 3.

5.1.9 Parameter Processing Error Flag

A "Parameter Processing Error Flag" (Fault Log Entries: Reg. 14, bit 8) is provided to allow the network master to determine whether any parameter values are unacceptable to the drive. If this flag is set (1), then one or more data register values transferred to the drive were rejected. If this flag is not set (0), then all data register values sent to the drive were accepted. Note that the "tune/config inputs enable" bit must be set (1) before the drive can read-in, and consequently process, any Tune/Config parameters. The parameter processing error flag is updated approximately every 100 milliseconds.

5.1.10 Data Retention Timing Requirements

All tunable and configurable drive input register values must be maintained by the network master's application program for at least 100 milliseconds to assure that they are seen by the drive. This is particularly relevant for data which is transition-detected by the drive.

Control/reference data types generally do not have this 100 millisecond requirement since they are scanned by the drive every 5 milliseconds. Special cases to this rule are the start input and the error log clear command. The start input requires a 0 to 1 transition in order to start the drive. The start input from the network may be delayed by the drive for up to 100 milliseconds. This is done to synchronize a drive start to the processing of new configurable data. In order for the network master to assure this 0 to 1 transition is detected by the drive, the network master must maintain **both** the 0 and 1 states for at least 100 milliseconds each. Values which are maintained for less time may not be detected by the drive.

The error log clear command bit is processed every 100 milliseconds even though it is defined in the control/reference data section. A 0 to 1 transition must be detected by the drive **after the network is active and the control source has been selected to be the network option** for the error log to be cleared. In order for the network master to assure this 0 to 1 transition is detected by the drive, it must maintain **both** the 0 and 1 states for a least 100 milliseconds each.

5.1.11 Inaccessible Drive Parameters (Keypad Only parameters)

There are a few GV3000 parameters which are not accessible through drive data registers, and therefore, are not accessible through the DeviceNet network. Table 5.4 is a list of parameters that are inaccessible. Because most of the inaccessible parameters are related to local drive control functions only, the inability to access the parameters do not limit network control.

Table 5.2 – Inaccessible Parameters	
Description	Parameter
Second menu enable password	P.006
Terminal block digital inputs config	P.007
Terminal block speed reference selection	P.008
Second accel rate	P.017
Second decel rate	P.018
MOP acc/dec rate	P.023
MOP reset configuration	P.024
Multispeed preset 1	P.031
Multispeed preset 2	P.032
Multispeed preset 3	P.033
Multispeed preset 4	P.034
Multispeed preset 5	P.035
Multispeed preset 6	P.036
Multispeed preset 7	P.037
Multispeed preset 8	P.038
Restore parameters defaults command	P.050
Program disable password	P.051
Network drop number	P.060
Vector torque loop self tune enable	U.008

5.2 Building Network Messages

5.2.1 General

Once a GV3000 drive with a network option card has been configured and is residing on an active DeviceNet network, the drive data registers will be accessible over the network with consideration to the above defined conditions (summarized in Section 5.1.7). These data registers may then be read and/or written to the drive by a DeviceNet master (scanner) or configuration utility. The following description provides the information necessary to program such a master or configuration device.

A master or configuration device may use all three of the connections typically available on a Group-2-Only-Server (Explicit, Poll and Bit-Strobed) to access register data. Accessing single registers on a random basis is usually through the Explicit connection. The network option card allows access to all the drive's data registers through the Explicit connection. Accessing a group of control data on a time-critical and periodic basis is usually through the Poll connection. The network card limits the data registers accessible to two group of those typically used for real-time control. The order and size of these groups are fixed and cannot be modified. Providing synchronization to other devices on the network is usually through the Bit-Strobe connection. The network card allows this connection to alternately manipulate the Start/Stop bits in the Sequence Control Word to start or stop the drive.

5.2.2 Loss-of-Communications Considerations

When the drive's "Control Source Select" (P.000) is set to OP (Option port), the drive will only transfer input register data to the regulator when the network option card informs the regulator that the network is "Active". The network status is normally only considered "Active" if a Poll connection has been established and is currently active. **Therefore, a Poll connection must be established by the master before any input register data can be transferred to the regulator.** An exception is the use of DeviceNet Manager to modify the drive's Tune/Config data registers. Setting the "Tune/Cnfg inputs enable bit" (Reg.32, bit 14) through DeviceNet Manager (which only uses the Explicit connection) will temporarily assert "Network Active" until the Tune/Config register data has been transferred to the drive's regulator.

When a Poll connection is closed or disrupted, the drive will enter a state as defined by the "Communications Loss Select" (P.062) parameter. If this parameter is set to 1-IET Fault, the drive will fault. The Fault may be cleared over the network by re-establishing the Poll connection and issuing the appropriate Reset command through the "Drive Control Word" (Reg. 32)

5.2.3 Poll Connection Data

The Poll connection provides the primary means of monitoring and controlling the drive. During normal operation, the DeviceNet master will transfer a group of OUTPUT data in a Poll Request. If the number of data registers (bytes) received matches the number expected by the network option card, it will accept the OUTPUT data and reply with a Poll Response containing a group of INPUT data. The number and specific data registers passed in a group is fixed; however, during drive configuration one of two sets of groups may be selected for operation (P.063). These two sets of groups are referred to as **control only** and **control+config** and are defined below.

Some applications will make use of a large number of drives with limited functionality connected to a single network. Only certain parameters and diagnostic information commonly used will be required for network control. Complete configuration over the network will not be a requirement for these lowest cost, highest density, highest network performance applications. This type of Poll connection will be referred to as the **control only** Poll connection. The network master will issue a Poll request that contains 3 words of data for output to the drive, and the drive will return a series of Poll response messages that contain 9 words of input data from the drive.

Other applications will accept a slower, lower density network in exchange for greater drive data access over the network. This type of Poll connection is referred to as the **control+config** Poll connection. When the drive is configured in this manner, the network master will issue a series of Poll requests that contains 17 additional words of data and the drive will return a series of Poll response messages that contains 6 additional words of data. Since a greater amount of network data is transferred, the network scan rate performance is affected.

Neither the **control** or the **control+config** formats access any data registers beyond the Basic set. If the Explicit connection is not used to access any data registers beyond Register number 64, P.061 should be set to select the Basic set.

Typically, the master must be programmed with the exact number of data registers to send and receive. If the size of the data sent from the master does not match that expected by the slave, the slave will neither accept the data or return a response. Likewise, if the data sent by slave does not match that expected by the master, the master will probably generate an error. An exception to this is the zero data length packet which has a special meaning to the network option card. Some scanners will send zero length data packets to the slaves if they are placed in a "standby" or "stop scan" mode. **When the network option card receives a zero length Poll or Bit-Strobe request, it will reset the Start and Stop bits in the Sequence Control Word (Reg. 32, bits 0 and 1) to stop the drive.**

Table 5.3 contains a summary of Poll packet sizes

Table 5.3 – Data Levels / Data to and from Drives		
Data Level	Data to Drive	Data from Drive
Control only	6 bytes	18 bytes
Control + config	46 bytes	30 bytes

Table 5.4 shows the Poll Connection Command Data Format

Table 5.4 – Poll Connection Command Data		
Word #	Drive Register #	Description
0	32	Drive Control Word
1	33	Network speed/torque reference
2	34	Network trim reference
(Poll connection consumption size = 6 bytes)		
The following additional data is sent in the Poll command message if the drive is configured to accept control+config data in the Poll command message (See Section 5.1).		
Word #	Drive Register #	Description
3	37	Accel time
4	38	Decel time
5	39	Minimum speed
6	40	Maximum speed
7	41	Current limit percent
8	42	TS analog input offset
9	43	TS analog input gain
10	44	TS analog input configure
11	45	Trim gain
12	46	Draw gain
13	47	(Vector) Speed proportional gain
14	48	(Vector) Speed integral gain
15	49	Jog reference
16	51	Function loss response
17	52	RPM display scale
18	53	Control Booleans (see register table)
19	56	Output relay configuration
20	57	Trim ref source
21	58	Torque ref source / OCL feedback source
22	62	Option communications loss select
(Poll connection consumption size = 46 bytes)		

Table 5.5 shows the Poll Connection Reply Data Format

Table 5.5 – Poll Connection Reply Data		
Word #	Drive Register #	Description
0	0	Status word (see register table)
1	1	Selected speed reference
2	2	Speed sum
3	3	(Vector) Speed feedback
4	4	TS analog input value
5	5	RPM display
6	6	Volts display
7	7	Amps display
8	8	Power display / Network output reg 1
(Poll connection production size = 18 bytes)		
The following additional data will be returned in the Poll reply message if the drive is configured to return control+config data in the Poll reply message message (See Section 5.1).		
Word #	Drive Register #	Description
9	12	Fault latch bits, word 1
10	13	Fault latch bits, word 2
11	14	Number of error/faults, parameter processing error flag
12	15	Error/fault log entries (n -1) and (n)
13	16	Active control source
14	27	Elapsed time meter readout
(Poll connection production size = 30 bytes)		

5.2.4 Bit-Strobed Connection Data

The DeviceNet "Bit-strobed" connection provides a means by which the master device can broadcast a single command message to all devices on the network. Each device receives the message at exactly the same time with a control bit specifically for each device on the network. The network option card makes use of its "bit" in the bit strobe command to accomplish synchronized drive startup. If a bit-strobe command is received, the network option card will interrogate its bit, and if set, will attempt to start the drive by setting both Start and !Stop bits in the Drive Control Word Register. If the bit is not set, the network option card will attempt to stop the drive by resetting both the Start and !Stop bits in the Drive Control Word Register.

Note that the drive's other parameters must still be prepared for start operation with Poll or Explicit messages. The zero data length Bit-strobe request will cause the network option card to behave the same as if it received a reset bit. Additionally, the Poll connection must be active to prevent a Loss of Communications Fault.

Note: The GV3000 only reads the run control word approximately every 100 milliseconds if the Tune/config data is being written to the drive (20 mS otherwise), therefore, drive synchronization can be skewed by up to 100 milliseconds. Also note that when the controller sends the bit-strobe command to start the drive, the run control word in the Poll command must be updated (the STOP bit deactivated), or the drive will not run.

5.2.5 *Explicit Connection Data*

All drive registers with the exception of the Drive Control Word (Reg. 32) can be accessed through the DeviceNet Explicit connection. A master scanner or configuration utility supporting the Explicit connection will require a DeviceNet object "path" to each drive register which is to be accessed. This path requires an object, instance and attribute number. Use the following path format for accessing drive data registers:

Class number: 185 (0B9hex)
Instance number: 1
Attribute number: Specific Drive Register Number (See Horner Electric's Supplement [SUP-0096].)

Technically, the option card supports the Explicit connection services "Get_attribute_single" and "Set_attribute_single" to access a data register with the above provided path. Should the master scanner or utility require a Service Code, provide the following:

Read Register (Get_attribute_single): 10 (0Ahex)
Write Register (Set_attribute_single): 16 (10hex)

Configuration utilities such as DeviceNet Manager may retrieve the data registers "path" information from the provided EDS file.

As described above, the drive regulator will only transfer register input data when P.000 is set to 2 (Option card) and the Poll connection is active. However, it is valid to pre-load data registers through the Explicit connection before a Poll connection is established.

An exception is when a master accesses the Drive Control Word with only the Explicit connection active. If the "Tune/Cnfg input enable" bit is set, the network option board will temporarily inform the drive regulator to transfer the Tune/Config data registers. While this exception is provided to allow operation with DeviceNet manager, it is not recommended for use by a controlling scanner. Alternately, the scanner should enable this transfer by setting the "Tune/Cnfg input enable" bit through the active Poll connection.

APPENDIX A: ACCESS TO DRIVE DATA REGISTERS

A1 DRIVE STATUS

A1.1. General

The remote run-time status of the drive is typically returned in Drive Registers 0 through 11. These values reflect the drives actual status regardless of the Control Source or the Auto/Remote mode. Refer to Horner Electric's Supplement (SUP-0096), Table1 (description column) to determine the Registers. Registers 0, 1 and 5 are covered in more detail in this appendix.

a. Register 0: Status Word

The first half of the word provides a bit-mapped run-time status of the drive similar to that which is displayed by the keypad. The second half of the word provides an indication of the physical inputs to the Control Terminal.

The "drive ready" status bit (Status Word: Reg. 0, bit 0) is used to indicate that a 0 to 1 transition on the start input will start the drive. The drive ready status bit is ON (1) when all of the following conditions are met and OFF (0) when one or more conditions are not met:

- No drive faults are active (Fault Active: Register 0, bit 2)
- Stop input is ON (1) (!Stop: Register 32, bit 1)
- Front-panel STOP/RESET button is not pressed
- Function loss TB input closed (monitored w/Function Loss: Register 0, bit 12)

b. Register 1: Selected Speed Reference

This register returns the currently selected speed reference. This value is scaled from 0 - 4095 where 4095 is the maximum allowable value. (i.e. The maximum 4095 value may correspond to 10 Volts at the Control Terminal: Analog Speed Reference Input or the maximum value placed in Register 33).

c. Register 5: RPM Display

This value returns the current output frequency (scaled) of the motor. The value returned is scaled according to those formulas presented in the GV3000/SE AC General Purpose (Volts/Hz) and Vector Duty Drive Software Startup and Reference Manual under Speed Display Scaling (P.028).

A1.2 Drive Control

A1.2.1 General

Network run-time drive control consists primarily of manipulating Drive Registers 32, 33, and sometimes, 34. Once in OPtion mode, these parameters will be used to control the drive alternately to those values input through the Control Terminal and/or Keypad when the drive is in LOCaL or rEmote mode.

A1.2.2 Register 32: Drive Control Word

The bits in this register are used by the drive alternately to the Discrete voltage inputs to the Control Terminal. Generally, asserting a bit in the Drive Control Word while under OPtion mode performs the same function as asserting a control voltage on the Control Terminal while under reMote mode. Exception and special conditions are listed as follows:

1. Before the drive can be started with the Start bit, the conditions which activate the Drive Ready bit into the Status Word (Register 0) must be active.
2. Start bit must make a high to low transition to start the drive. Once Drive Status indicates the drive started, the Start bit can be reset. The drive is then stopped by releasing the Stop bit .
3. Tune/Cnfg input enable bit will cause drive to accept option card default (or updated) Tune/Config parameters. Setting this bit can severely alter drive operation (See Chapter 5).

A1.2.3 Register 33: Network Speed/torque Reference

This register is used to control the drive's speed reference when the drive is in Option mode, and the Remote/Local control is in Remote mode. This value is scaled such that the 0 is equal to stop and the value 4095 is equal to full speed.

APPENDIX B: CONFIGURING DRIVE WITH DEVICENET MANAGER

B1 DEVICENET MANAGER

B1.1 General

DeviceNet Manager is a popular software package distributed by Allen-Bradley, which provides an on-line method of programming Master and Slave DeviceNet devices. When DeviceNet Manager is loaded with the provided EDS file, it may be used to program Tune/Config Drive Parameters (Registers) when the Network Option card is on-line. However, only a majority of the first 64 drive registers are accessible through DeviceNet Manager. Those first 64 parameters do include the drive Tune/Config parameters which are most commonly accessed. Access to Tune/Config parameters above the first 64 will generally require an alternate method of configuration such as the drive's keypad.

The lower 64 drive registers are divided into two sections. Within the first 32 registers are read-only parameters which reflect the drive's current values irregardless of which source is controlling the drive. Within the second set of 32 registers, are the writeable registers which will be loaded to the drive regulator under certain conditions. These conditions are covered in Chapter 5:

1. Drive parameter (P.001) must be set to Option mode.
2. Drive must be stopped.
3. Tune/Cnfg input enable bit must be set (manually through DeviceNet Manager) to actually set "Network Active" and copy upper 32 registers to drive.

Before DeviceNet Manager can be used to configure the drive, the provided EDS file must be installed. Once installed, the DeviceNet Manager may be used add GV3000 drives to a Project and configure them on-line. While examples are provided for the EDS installation and Device level configuration of the GV3000, it is not within the scope of this document to provide complete instruction on the use of DeviceNet Manager. Therefore, the user should be familiar with the DeviceNet Manager Software and should give precedence to the DeviceNet Manager User Manual on any variations with those presented here.

B1.2 Installation of EDS file

The installation of the EDS requires that the DeviceNet Manager Software must previously be installed. Run the DeviceNet Manager software. From the Utilities Menu, select "Install EDS Files..."

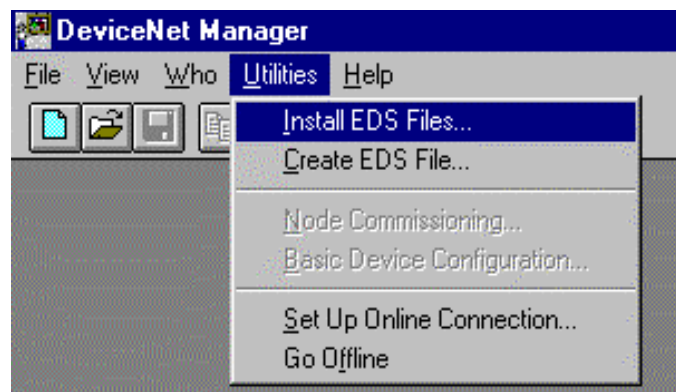

Figure 1

The following menu appears:

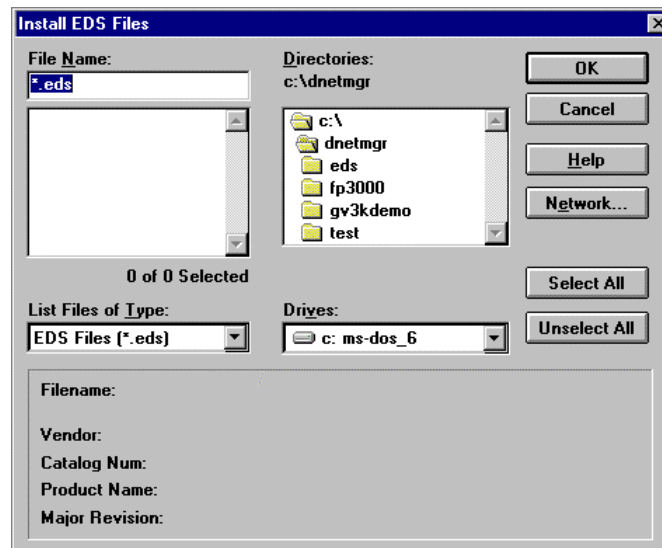

Figure 2

Select your diskette drive (A or B), and the following file is listed:

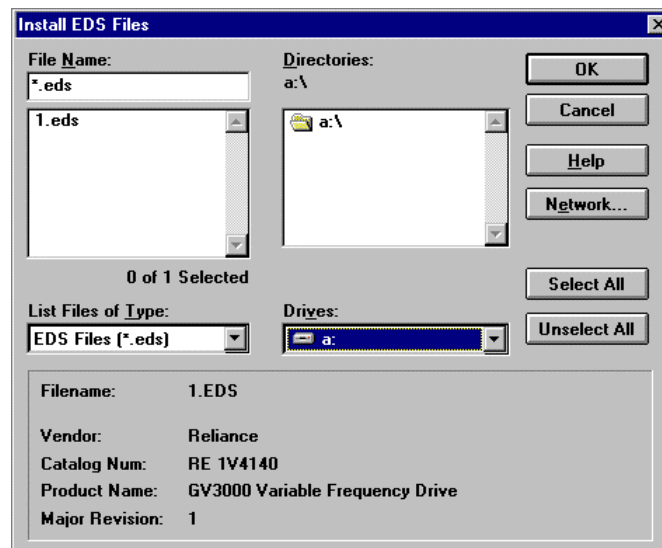

Figure 3

Information regarding the file is shown in the lower portion of the screen. Select the file named "1.eds" and press "OK". The DeviceNet Manager software now installs the EDS file to the appropriate directory on the user's hard disk drive.

B1.3 Adding a GV3000 Device to a Project

Now that the EDS file is installed, the Reliance GV3000 Variable Frequency Drive is added to the list of available DeviceNet products. Now a new or existing DeviceNet Project can be configured with the Reliance GV3000 Variable Frequency Drive. To create or modify DeviceNet Projects and Networks, refer to the DeviceNet Manager Software User Manual.

In the example below, a project named "Press_Rm" is open, and the Network named "Blanker" is currently selected. The only device currently configured for that network is a SLC 500 DeviceNet Scanner module.

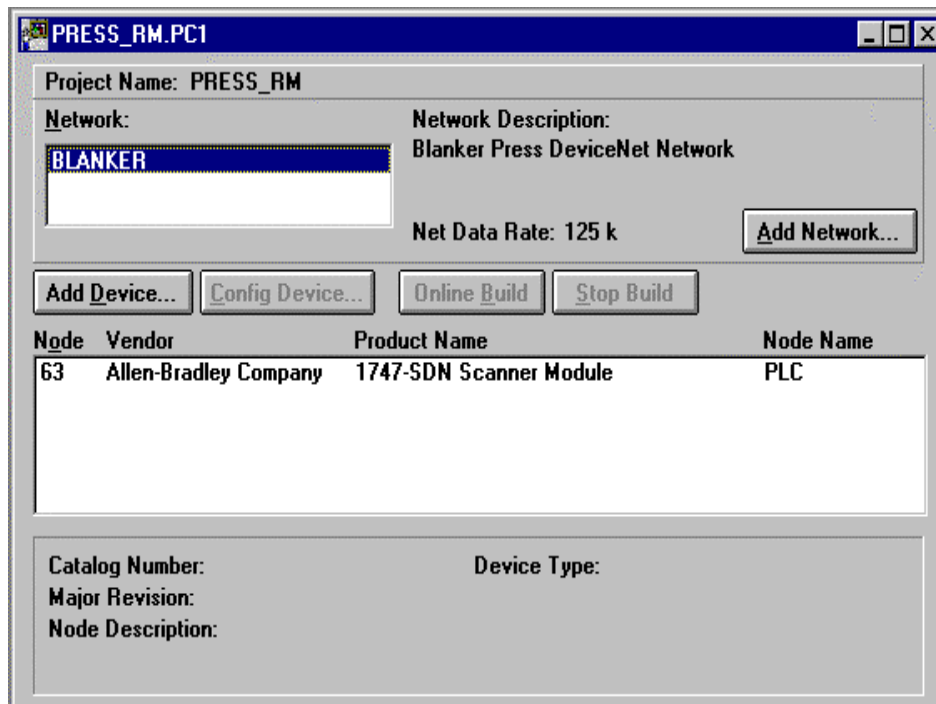

Figure 4

To add a Reliance GV3000 Variable Frequency Drive to the network, press the "Add Device" button, and a list of DeviceNet devices is displayed. Selecting either "All Product Types" or "Generic" displays a group of devices, which include an entry for the Reliance GV3000 Variable Frequency Drive.

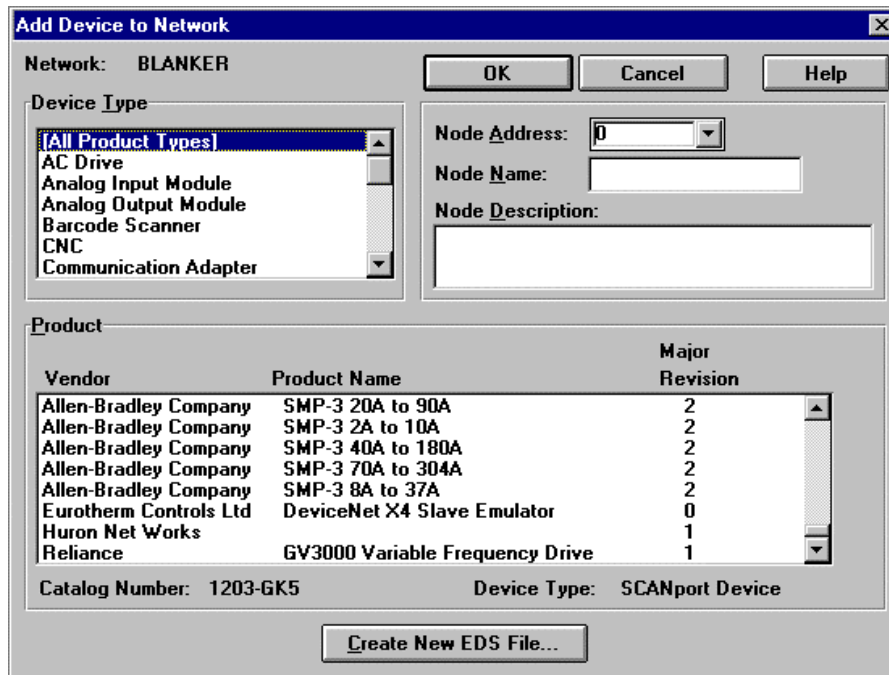

Figure 5

The GV3000 may be added to the configuration by high-lighting that entry and supplying the other Node information. For example, to add a GV3000 as Node 1, select the GV3000 item and change the Node Address to 1. Optionally add an Name and Description, and press "OK." The GV3000 is now added to the list of devices on the BLANKER network as shown in Figure 6.

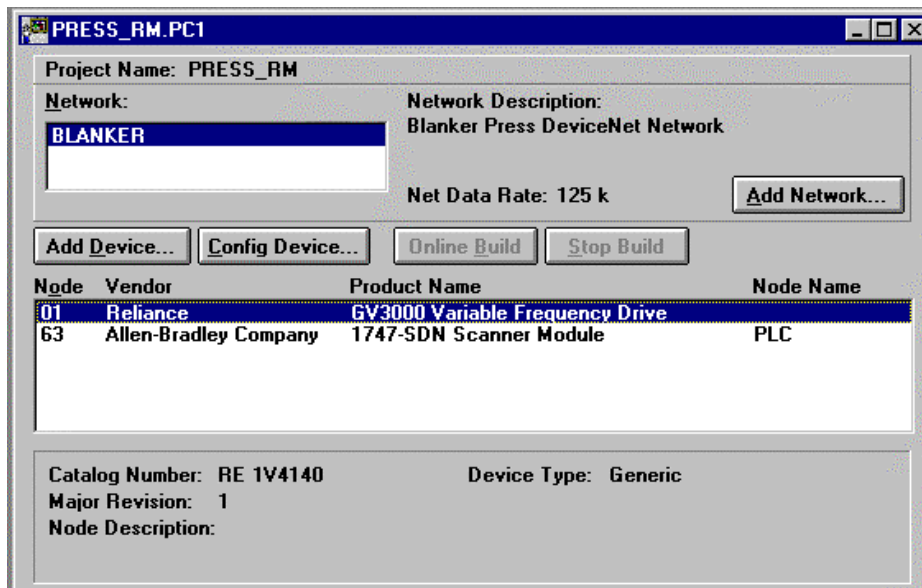

Figure 6

B1.4 Configuring a GV3000 Device

B1.4.1 Display Configuration

Once the GV3000 entry is placed on the Project/Network screen, the user may zoom into that selection to configure the module. Double-clicking on the GV3000 item brings up the “Device Configuration” screen, which presents a detailed listing of the GV3000 parameters.

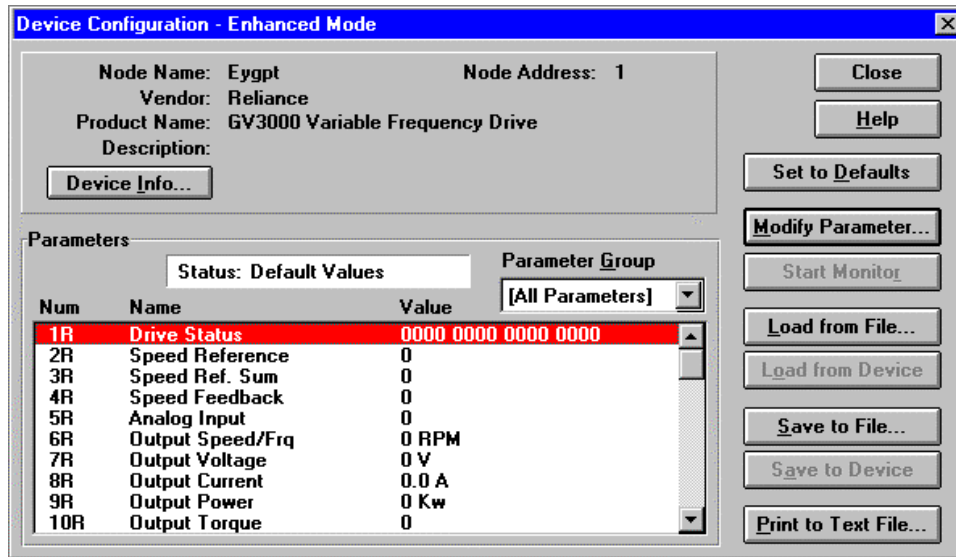

Figure 7

B1.4.2 Off-line/On-line Configuration

This device configuration screen displays two sets of information. If the “Status” field is displaying “Default Values,” the information is coming from the EDS file and is off-line. If the “Status” field is displaying “Device Values,” the information is coming from the actual on-line GV3000. Generally, the configuration is done on-line unless the configuration is being saved to the project to be loaded at a later date. To place the device on-line or off-line, refer to the DeviceNet Manager Users Manual.

B1.4.3 Display Groups (Current/Preload)

Those parameters which are displayed and/or modified are sub-divided into three groups: All Parameters, and Current: T/C, and Preload: T/C. “All Parameters” displays a significant portion of the first 64 drive registers. “Current: T/C” displays a significant portion of the Tune/Config parameters which are currently being used by the drive (those T/C parameters which are read-only and are in the lower 32 registers). “Preload: T/C” displays a significant portion of the Tune/Config parameters (those T/C parameters which are read/write and are in the second set of 32 parameters) which are loaded to the drive when conditions are met as described in Sections B1.4.4 and B1.4.5.

The groupings are useful such that the user may select “Current: T/C” from the Parameter Group box to display and record just the drives current parameter values (assuming device on-line). Then the user may select “Preload: T/C” from the Parameter Group box to display just the current preload values. The user may, then, modify and load the preload values as described in the following section.

B1.4.4 Modifying a (Preload) parameter

Assuming that the configuration is currently on-line, from the Device Configuration screen, double-clicking on a Parameter which needs modification brings up detailed information. Note that the Parameter number associated with the parameter does not match the drive register number. Therefore, select the parameter by name. Also note that detailed screen will vary slightly according to the parameter type. The following screen shows the detailed screen for the Accel Rate parameter.

The screenshot shows a dialog box titled "Device Configuration - Modify Numeric Parameter". It contains the following fields and controls:

- Parameter #31**
Accel Time
Status: Online Configuration
- Value**
20.0 (Sec.)
Minimum: 0.1, Maximum: 999.9
Default = 20.0
- Internal Value**
200
Unsigned Decimal
- Buttons:** OK, Cancel, Load from Device, Save to Device, Start Monitor, Param Help, Help, Select Default

Figure 8

The parameter may be modified by changing the value field. This may be done directly or the mouse may be used on the slide bar. Note that DeviceNet Manager may impose limitations on this field if the parameter has a valid value range. The recommended default may also be selected by clicking the "Select Default" button. Once the value is correct it must be loaded to the GV3000. This is accomplished by clicking the "Save to Device" button. To verify the GV3000 received this value, the user may click the "Load from Device" button and verify value is the same as that downloaded.

B1.4.5 Loading Preloaded Parameters to Drive

Once all the Tune/Config parameters (registers) are modified to the correct value, they may be loaded into the drive memory. This requires that parameter P.000 be set to Option and that the drive is stopped. Since the preloading through DeviceNet Manager only includes the first 64 drive data registers, parameter P.061 must be set to 0 (Basic) to prevent the upper drive registers from being loaded with non-initialized data.

From the "Device Configuration" parameter list, select "Param Write Control"

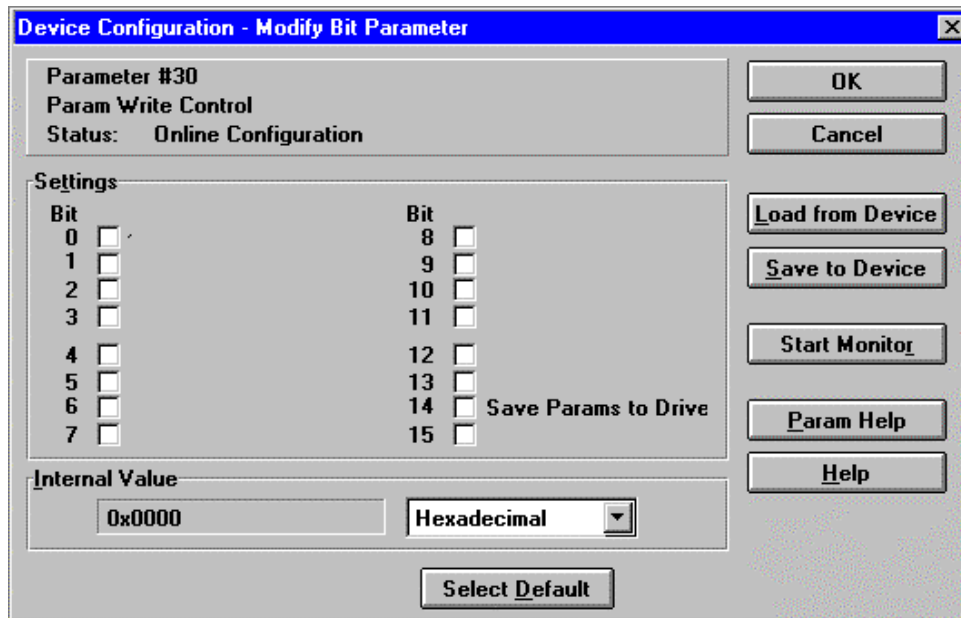

Figure 9

Set the "Save Params to Drive" bit by clicking on it and then the "Save to Device" button. To verify that the drive accepted the command, click on "Load from Device" and verify that the "Save Params to Drive" bit is reset.

Additional verification that the drive recorded the parameters is to return to the "Drive Configuration - Enhanced Mode" screen and select the group "Current: T/C". Then click the "Read from Device" to retrieve the current parameters being used by the drive. The user may now verify the parameters were changed. Note that due to drive limitations a few of the parameters settable in the preload group are not readable in current group.

APPENDIX C: DEFAULT TUNE/CONFIGURATION REGISTERS

The Tune/Config data registers not explicitly preloaded through Explicit network messages contain default values as described in Table 1.

Register	Default Load Value
32	Stop
33	0
34	0
35	0
36	0
37	20.0
38	20.0
39	5.0
40	60.0
41	100
42	0
43	1.000
44	0
45	0
46	0
47	0
48	0
49	5.0
50	0
51	0
52	1800
53	0
54	0
55	0
56	0
57	0
58	0
59	0
60	0
61	0
62	0
63	P.063



07 May 1999

Revision pages for Horner Electric's DeviceNet Network Communication Option Board for use with Reliance Electric GV3000 AC Drive User Manual

HEC-GV3-DN, Third Edition

Attached to this cover page is a revision for the Horner Electric DeviceNet Network Communication Option Board for use with Reliance Electric GV3000 AC User Manual dated 22 September 1998 (**MAN0096-03**).

THESE REVISED REQUIREMENTS ARE NOW IN EFFECT.

New and revised pages may be issued periodically. For user manual updates, please contact Horner Electric Advanced Products Group, Technical Support Division, at (317) 916-4274 or visit our website at www.heapg.com.

Revision Key

Changes to text, tables or graphics contained in the attached revision are indicated as follows:

1. Added text is underlined.
2. Deleted text is ~~lined through~~.
3. New, revised, or deleted items are specified as such in ().

List of Effective Pages

*The most current user manual consists of the following list of effective pages including the attached revision pages: * Denotes new or revised pages*

Page	Date
Front Cover.....	Contained in MAN0096-03 dated 22 September 1998
2 – 21.....	Contained in MAN0096-03 dated 22 September 1998
*22.....	Revision Pages dated 07 May 1998
23-28.....	Contained in MAN0096-03 dated 22 September 1998
*29.....	Revision Pages dated 07 May 1999
30 -41.....	Contained in MAN0096-03 dated 22 September 1998

CHAPTER 5: NETWORK PROGRAMMING

(NEW)

WARNING: Risk of severe bodily injury or equipment damage exists. The drive restarts if the START and STOP bits in the control word are maintained **high**, and the PLC is switched from **Program** to **Run** mode. Precautions need to be taken to ensure that these mode switches do **NOT** create a hazard of bodily injury or equipment damage.

(Warning added 07 May 1999)

5.1 Drive Data Registers Overview

5.1.1 General

The drive is monitored and controlled over the network by reading and writing network commands (Explicit, Poll or Bit-Strobed) to the drive's data registers. The data registers are addressed over the network by a register number (Reg #) and contain 16 bit values. The data registers are divided into separate types according to function. Generally speaking, the **Tune/Config** registers hold an image of the P.xxx and U.xxx parameters accessible by the drive's keypad and the **Control/Reference** registers hold an image of the drives physical inputs (start, stop, speed ref., etc). When the drive is configured for network control and other certain conditions are met, the drive registers accessed by the network option card are selected as an alternate source for controlling the drive as opposed to the keypad and/or physical input.

Network data written to the drive's data registers is buffered before it is transferred to the drive's internal regulator. In order to minimize regulator board CPU loading, the rate of transfer of register data to the drive regulator varies for different data register types. Additionally, some register data transfer are blocked until additional conditions are met. The sections that follow describe each data type for input and output register data along with the drive's response and conditions for acceptance of transfer. The presented response times do not include DeviceNet transfer times.

The drive data registers which may be read or modified are listed in a table in Horner Electric's Supplement (SUP-0096). The table lists the register number, type, access and description for each register.

5.1.2 Input Data Update Response

The drive's input data is categorized as one of three types: control/reference, tunable or configurable. Control/reference inputs include data which require fast update rates. This includes data such as sequencing inputs (start, stop, run/jog, fwd/rev, etc.) and speed/torque reference. Control/reference inputs are transferred from the data registers to the regulator every speed loop scan period (for the GV3000, every 5 milliseconds), or as often as it is required by the drive. For example, if the drive is configured to obtain its torque reference from the option port, it reads this data from the option port every torque loop control scan.

Tunable inputs include parameters which typically require modification or adjustment while the drive is running. Tunable data includes parameters such as accel/decel rates, min/max limits, gains or offsets, etc. Tunable inputs are transferred from the data register to the regulator whenever the regulator performs the processing of new tunable parameters. This occurs approximately every 100 milliseconds while the drive is running or stopped.

Configurable inputs include parameters, which alter the way that the drive operates in such a way that they cannot be modified while the drive is running. Configuration data includes parameters such as reference source selection, I/O configuration, motor/tach nameplate data, etc. Configurable inputs are transferred from the data registers to the regulator whenever the regulator performs processing of new configuration parameters. This occurs approximately every 100 milliseconds while the drive is stopped. Values sent from the network master while the drive is running are not read in and used by the drive regulator until the drive is stopped.

Typically, the master must be programmed with the exact number of data registers to send and receive. If the size of the data sent from the master does not match that expected by the slave, the slave will neither accept the data or return a response. Likewise, if the data sent by slave does not match that expected by the master, the master will probably generate an error. An exception to this is the zero data length packet which has a special meaning to the network option card. Some scanners will send zero length data packets to the slaves if they are placed in a "standby" or "stop scan" mode. **When the network option card receives a zero length Poll or Bit-Strobe request, it will reset the Start and Stop bits in the Sequence Control Word (Reg. 32, bits 0 and 1) to stop the drive.**

(NEW)

WARNING: Risk of severe bodily injury or equipment damage exists. The drive restarts if the START and STOP bits in the control word are maintained **high**, and the PLC is switched from **Program** to **Run** mode. Precautions need to be taken to ensure that these mode switches do **NOT** create a hazard of bodily injury or equipment damage.

(Warning added 07 May 1999)

Table 5.3 contains a summary of Poll packet sizes

Data Level	Data to Drive	Data from Drive
Control only	6 bytes	18 bytes
Control + config	46 bytes	30 bytes

Table 5.4 shows the Poll Connection Command Data Format

Word #	Drive Register #	Description
0	32	Drive Control Word
1	33	Network speed/torque reference
2	34	Network trim reference
(Poll connection consumption size = 6 bytes)		
The following additional data is sent in the Poll command message if the drive is configured to accept control+config data in the Poll command message (See Section 5.1).		
Word #	Drive Register #	Description
3	37	Accel time
4	38	Decel time
5	39	Minimum speed
6	40	Maximum speed
7	41	Current limit percent
8	42	TS analog input offset
9	43	TS analog input gain
10	44	TS analog input configure
11	45	Trim gain
12	46	Draw gain
13	47	(Vector) Speed proportional gain
14	48	(Vector) Speed integral gain
15	49	Jog reference
16	51	Function loss response
17	52	RPM display scale
18	53	Control Booleans (see register table)
19	56	Output relay configuration
20	57	Trim ref source
21	58	Torque ref source / OCL feedback source
22	62	Option communications loss select
(Poll connection consumption size = 46 bytes)		